

EKO ALVİTRA DİLATASYON PROFİLLERİ

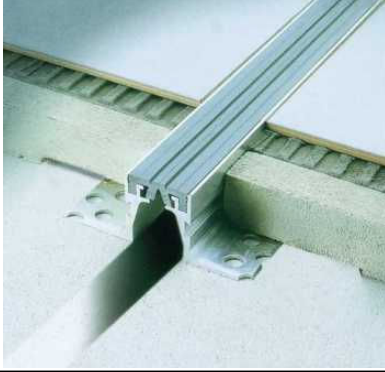

- Duvar, tavan ve zemindeki 12 mm açıklıktan 200 mm genişliğe kadar olan dilatasyon derz açıklıklarına uygun tipleri mevcuttur. Alüminyum profil boylarının standart boyları 4 metredir.
- Bina içinde döşemede, duvar ve tavanlarda ,dış cephede güvenle uygulanabilir. Otoparklar ve ağır yüke maruz alanlar için özel metal profil sistemleri üretilmektedir.
- Dilatasyon profilleri delikli montaj braketleri sayesinde döşeme betonu veya sıva altına çok iyi yerleşir.
- Kaplama üstü uygulanacak profiller kir tutmayacak şekilde düz yüzeyli ve naturel eloksallıdır.
- Profiller her yöndeki hareketleri absorbe eder.
- Alüminyum profillerle kullanılan kauçuk fitiller uzun ömürlü, her türlü iklime, yağlara, asitlere ve asfalta dayanıklı yüksek kalite malzemeden üretilmiştir.
- Kauçuk fitil istenildiğinde değiştirilebilir. Fitil boyları kesintisiz 20 metrelik boylarda uygulanabilmektedir.
- Standart EPDM kauçuk fitiller siyah renktedir. Gri, krem, kahverengi renk seçenekleri yüksek kalitede PVC olarak mevcuttur. Profiller su yalıtımında kritik rol oynar.

EXPANSION JOINT PROFILES :

- Aluminium profiles' standart production lenght is 4 meters.
- Rubber insert is replaceable at any time.
- Rubber insert can be installed in lenghts up to 20 meters.
- Insert colors are black, grey, beige and brown.
- Profiles absorbs settlements.
- Good fixing by perforated mounting brackets.
- Flexible insert made of high quality rubber, long wearing, weather resistant, temperature resistant, extensively resistant to oils, acids and bitumen.
- Our surface fixing profiles has a smooth surface and has no gaps to reduce dirt accumulation.
- Our profiles are suitable for shopping centers, supermarkets, airports, exhibition halls and hospitals.
- Our profiles series have types for floor wall ceilings for every expansion joint width and has all-metal profiles for heavy duty floors and car parks.

ZEMİN DİLATASYON PROFİLLERİ (DL 1A-DL 2A Serileri)

E.J. PROFILES FOR FLOOR

DL 1A 12*25

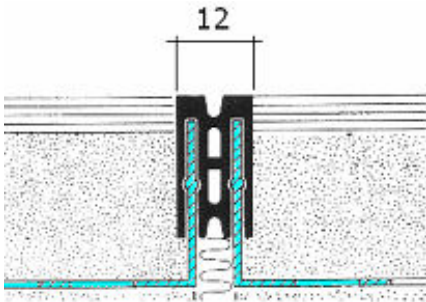

DL 1A 25*15

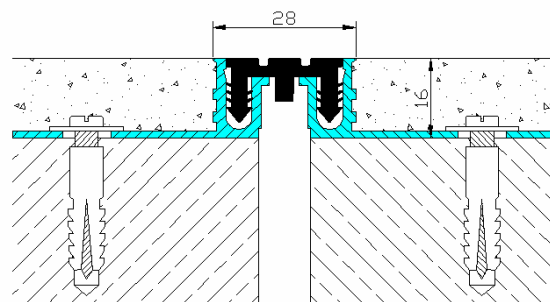

DL 1A 35*35
DL 1A 35*50

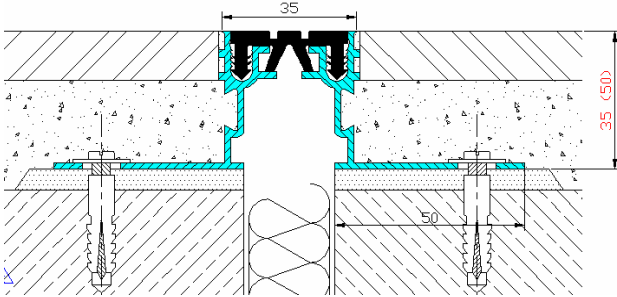

DL 1A 35*15

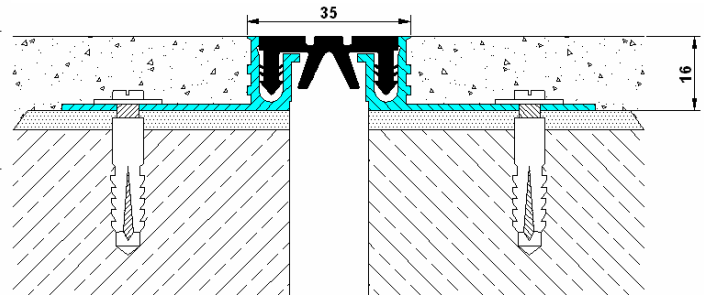

DL 1A 50*35
DL 1A 50*50

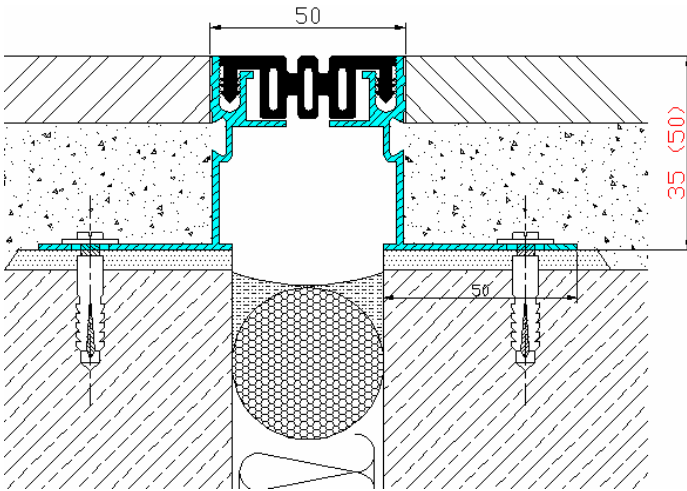

DL 1A 50*15

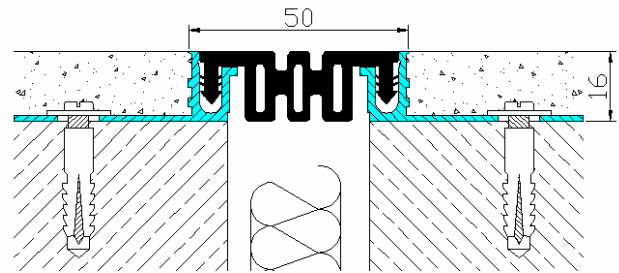

DL 1A 80*50

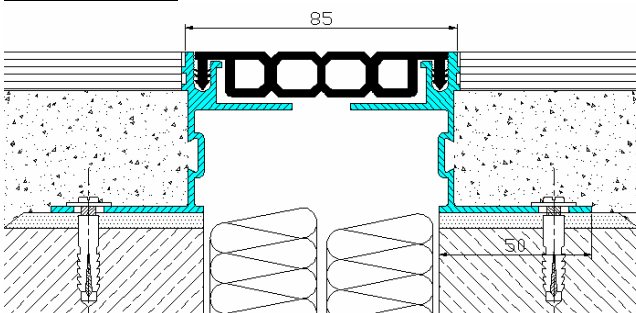

DL 1A 100*50

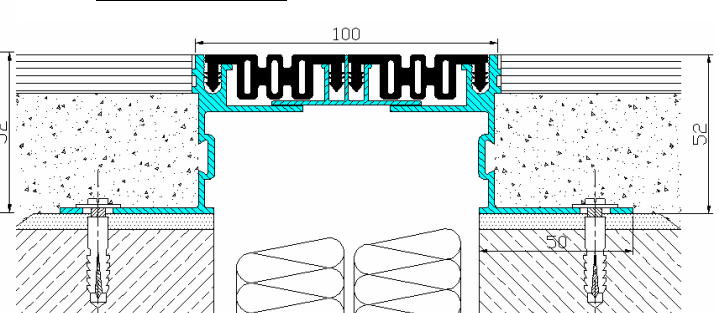

DL 1A 135*35

DL 1A 135*50

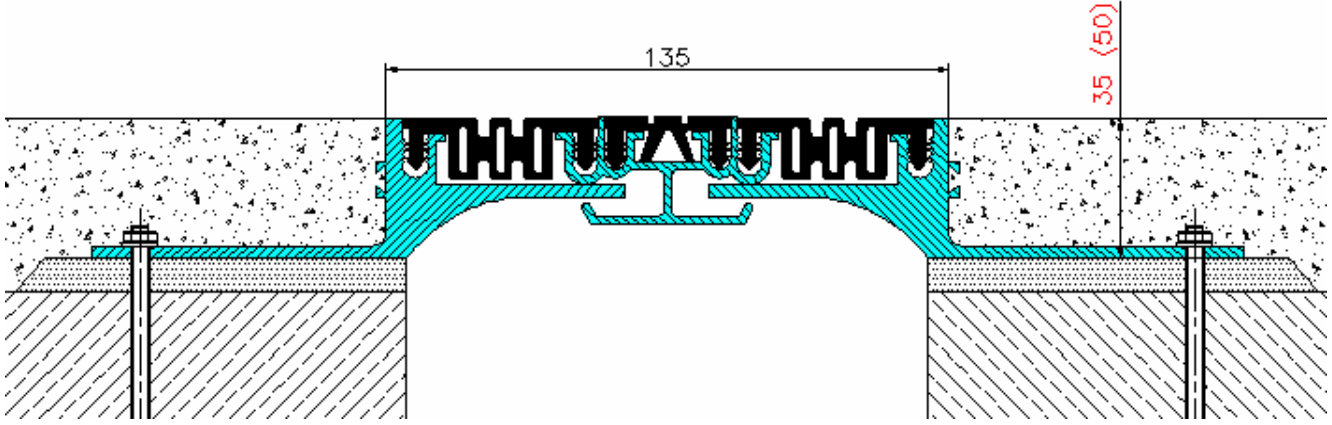

DL 2A 50*35

DL 2A 50*50

DL 3A 50*50

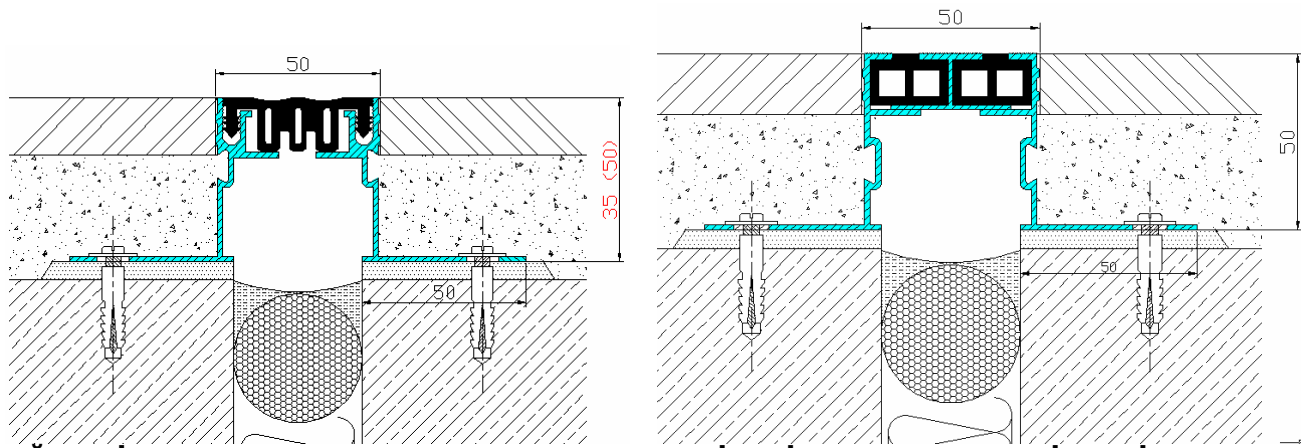

**AĞIR HİZMET VE OTOYOL KAPLAMA ALTI ZEMİN DİLATASYON PROFİLLERİ
(DL 1M-DL 2M Serileri)**

ALL-METAL E.J. PROFILES FOR HEAVY DUTY FLOORS AND CARPARKS

DL 1M SERİSİ

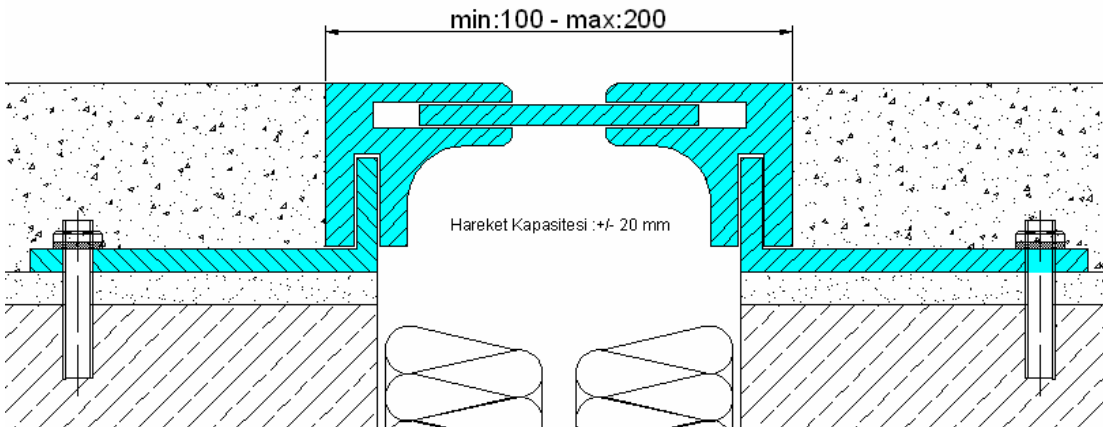

DL 2M SERİSİ

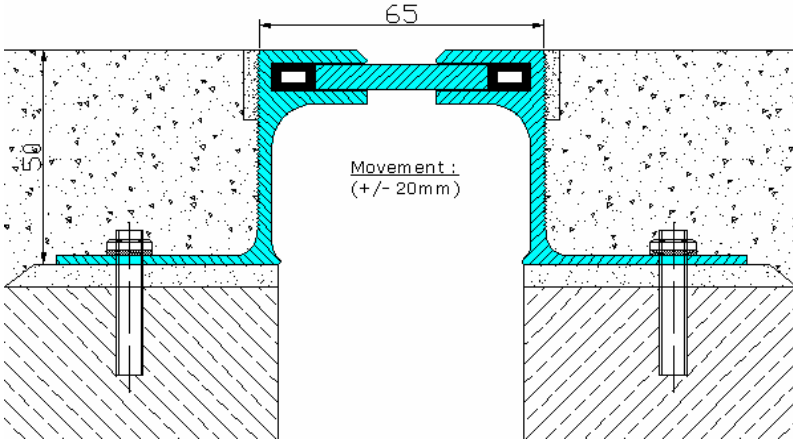

**AĞIR HİZMET VE OTOYOL KAPLAMA ÜSTÜ ZEMİN DİLATASYON PROFİLLERİ
(DL 1FM serisi)**

ALL-METAL E.J. PROFILES FOR HEAVY DUTY FLOORS AND CARPARKS(FOR SURFACE FIXING)

DL 1FM SERİSİ

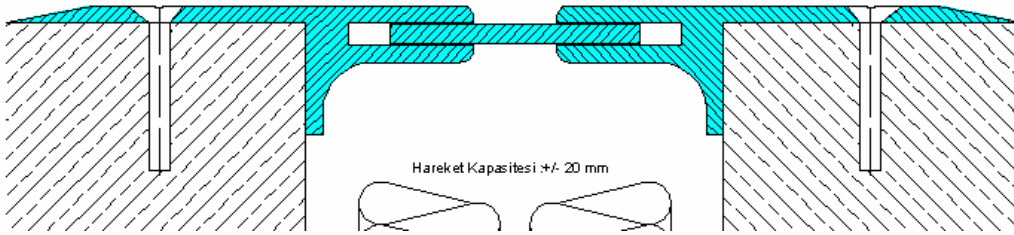

ZEMİN KÖŞE DİLATASYON PROFİLLERİ (DL 1B-DL 1C Serileri)
E.J. PROFILES FOR FLOOR CORNER

DL 1B 35*35
DL 1B 35*50

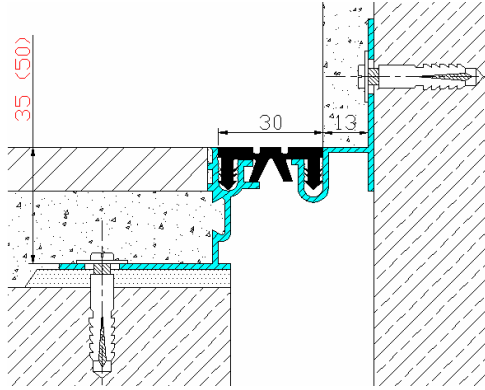

DL 1C 35*35
DL 1C 35*50

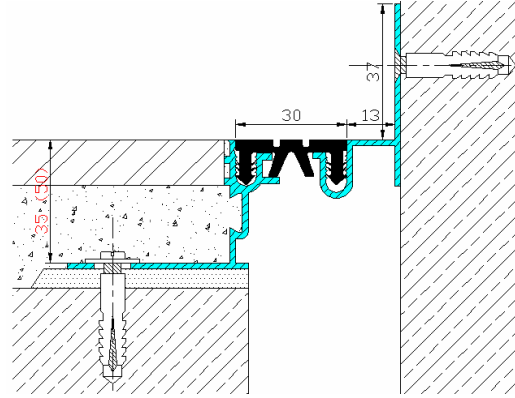

DL 1B 50*35
DL 1B 50*50

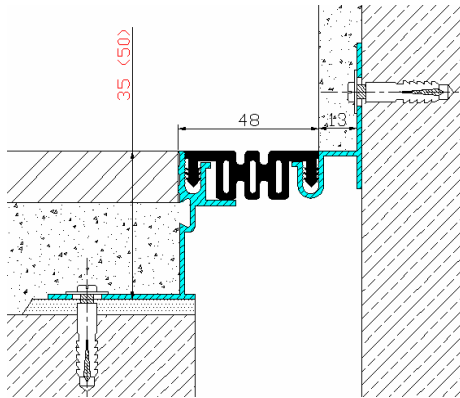

DL 1C 50*35
DL 1C 50*50

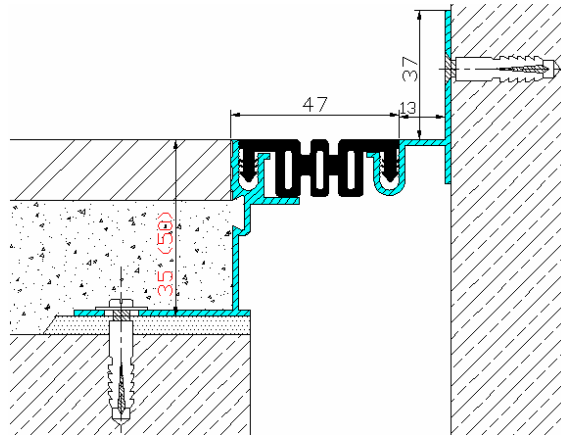

DL 1B 100*50

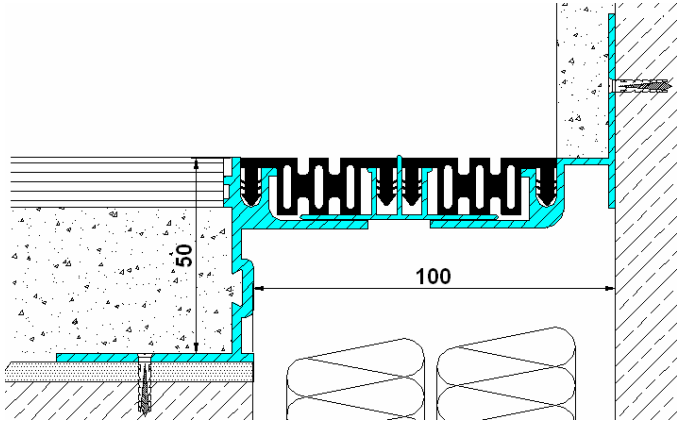

DL 1C 100*50

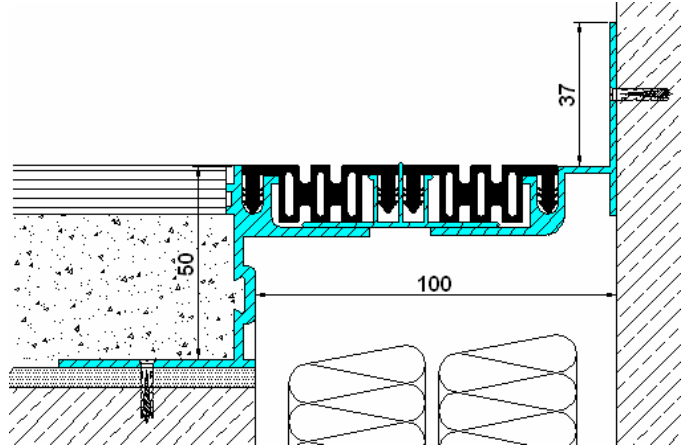

DUVAR, TAVAN, (ZEMİN) KAPLAMA ÜSTÜ DİLATASYON PROFİLLERİ (DL 1F serisi)
E.J. PROFILES FOR WALLS, CEILINGS, (FLOORS) FOR SURFACE FIXING

DL 1F 35*40
DL 1F 35*50

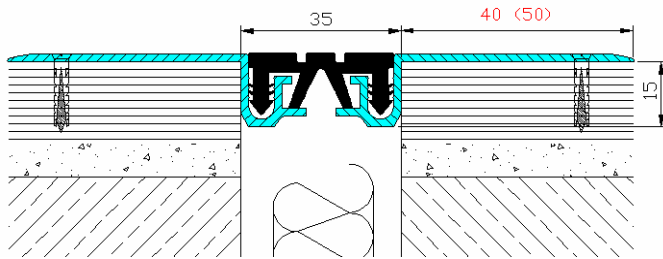

DL 1F 25*40

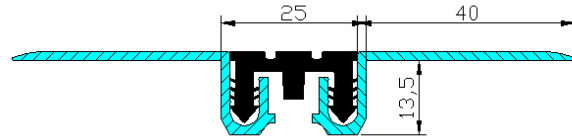

DL 1F 100*40
DL 1F 100*50
DL 1F 100*70

DL 1F 50*40
DL 1F 50*50
DL 1F 50*70

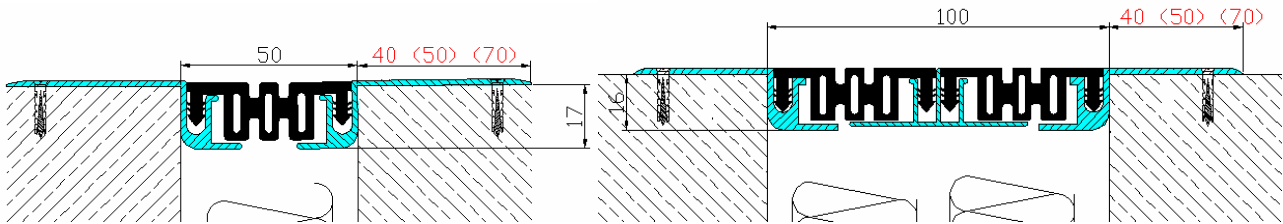

DL 1F 135*40
DL 1F 135*50
DL 1F 135*70

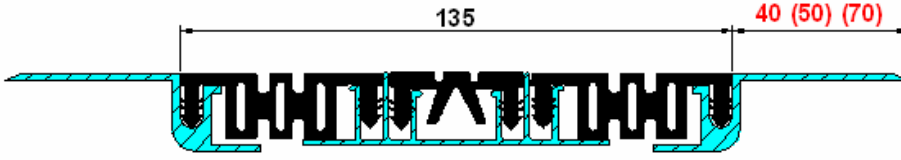

DUVAR, TAVAN KAPLAMA ÜSTÜ KÖŞE DİLATASYON PROFİLLERİ (DL 1FC serisi)
E.J. PROFILES FOR WALL AND CEILING CORNERS (SURFACE FIXING)

DL 1FC 25*40

DL 1FC 35*40
DL 1FC 35*50

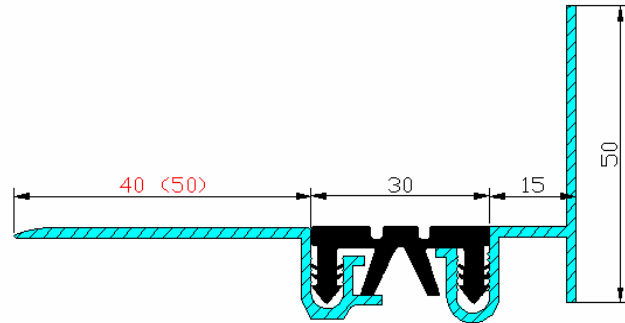
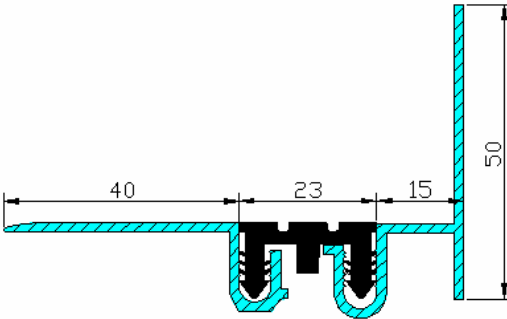

DL 1FC 50*40
DL 1FC 50*50
DL 1FC 50*70

DL 1FC 100*40
DL 1FC 100*50
DL 1FC 100*70

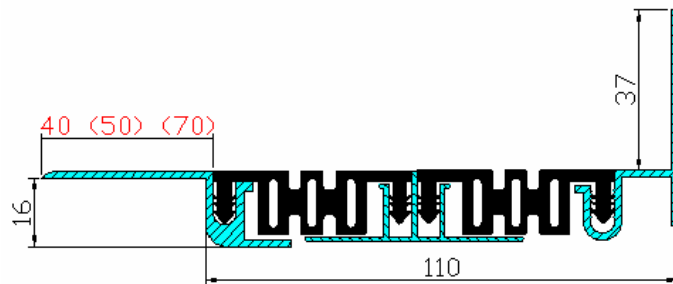
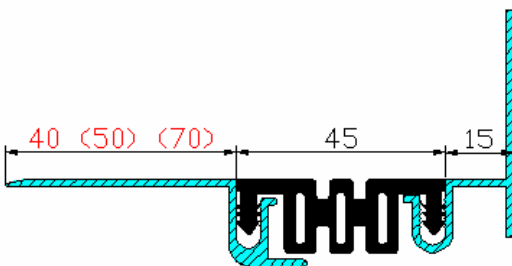

DL 1FC 135*40
DL 1FC 135*50
DL 1FC 135*70

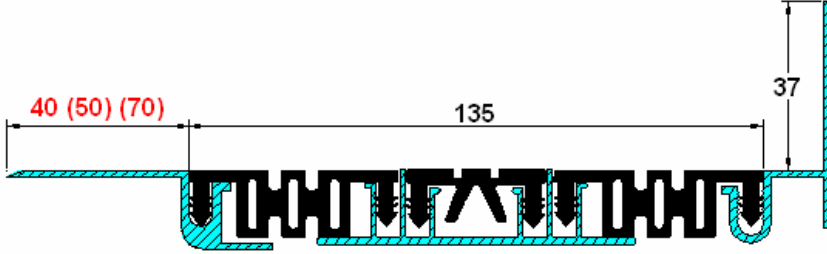

DUVAR TAVAN KAPLAMA ALTI DİLATASYON PROFİLLERİ (DL 1E serisi)
E.J. PROFILES FOR WALL AND CEILINGS (UNDER PLASTER)

DL 1E 25*15

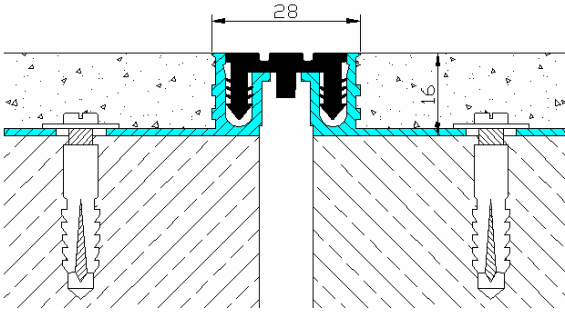

DL 1E 35*15

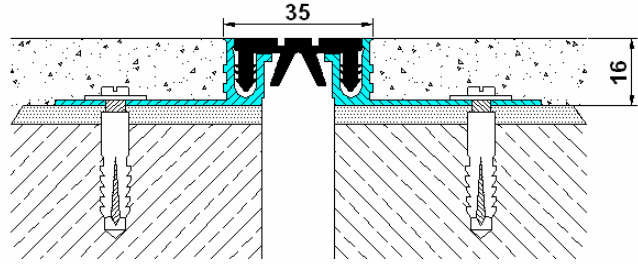

DL 1E 50*15

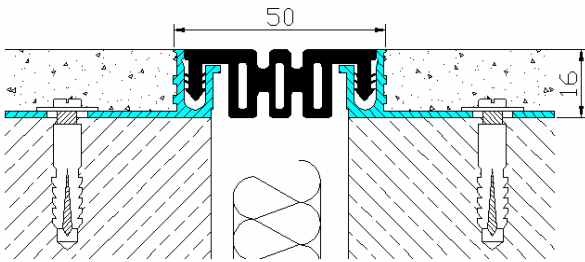

DL 1E 100*15
DL 1E 100*35
DL 1E 100*50

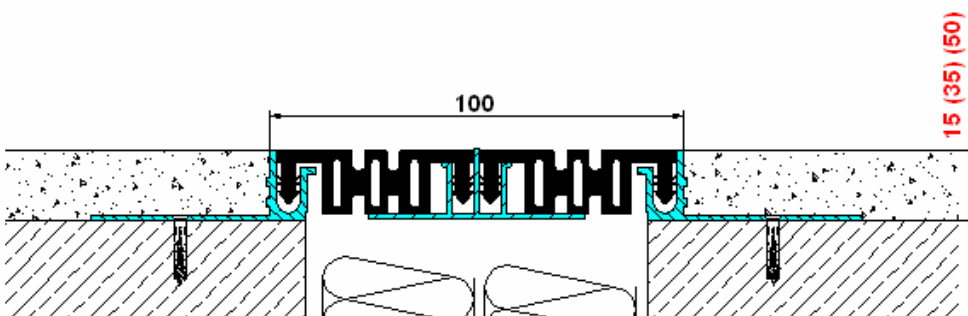

DL 1E 135*15

DL 1E 135*35

DL 1E 135*50

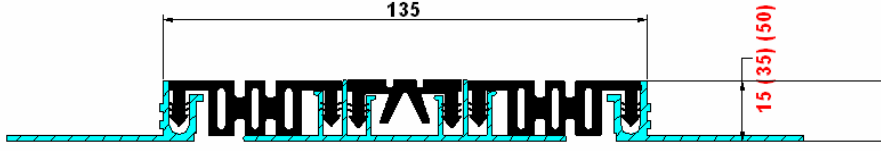

DUVAR, TAVAN KAPLAMA ALTI KÖŞE DİLATASYON PROFİLLERİ (DL 1EC serisi)

E.J. PROFILES FOR WALL AND CEILING CORNERS (UNDER PLASTER)

DL 1EC 25*15

DL 1EC 35*15

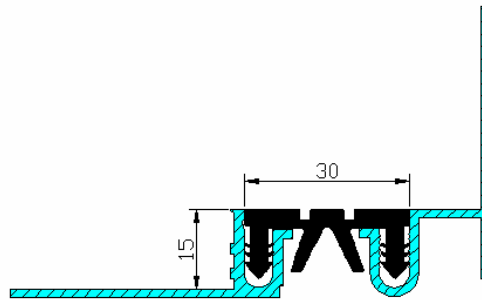
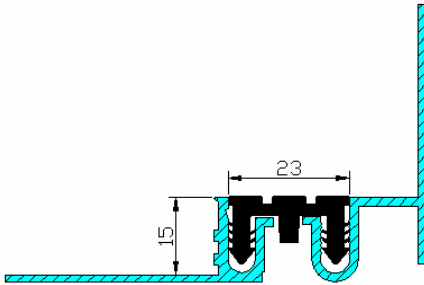

DL 1 EC 50*15

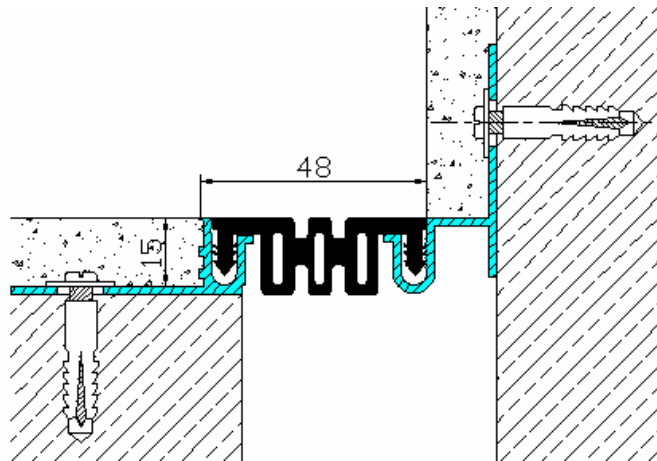

DL 1EC 100*15

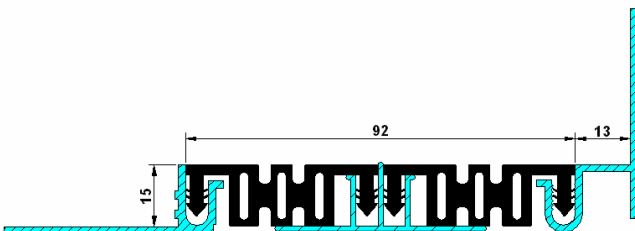

ZEMİN KAPAK PROFİLLERİ (DL 1FK-DL1 FKZ Serileri)
COVER PROFILES FOR FLOORS

DL 1FKZ 120



DL 1FKZ 150



DL 1FKZ 200



DUVAR, TAVAN KAPAK PROFİLLERİ
COVER PROFILES FOR WALL AND CEILINGS

DL 1 FK 120



DL 1FK 150



DL 1FK 200



DL 1 FK 40*70

DL 1FK 50*100

